

SETUP INSTRUCTIONS

PACKING LIST

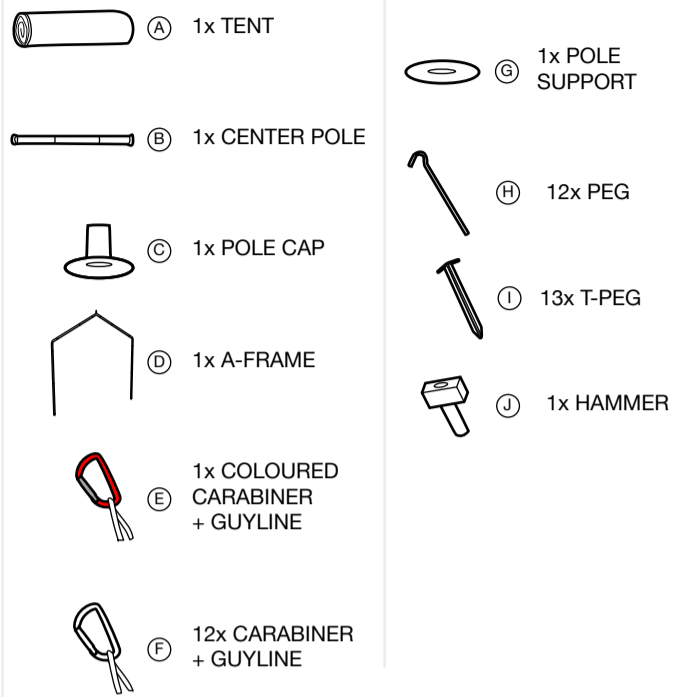

• This tent is made of a cotton based canvas, make sure to wet the entire tent before first use and let it dry completely to ensure waterproofness.
 • Make sure to always close the doors and windows of your tent during heavy winds.

LARGE BELL 4.4
 ESSENTIAL BELL 4.4

TENT Ø4,4m
 TENT + GUYLINES Ø 9,0m

MAJOR BELL 5.2
 ESSENTIAL BELL 5.2

Ø5,2m Ø 10,6m

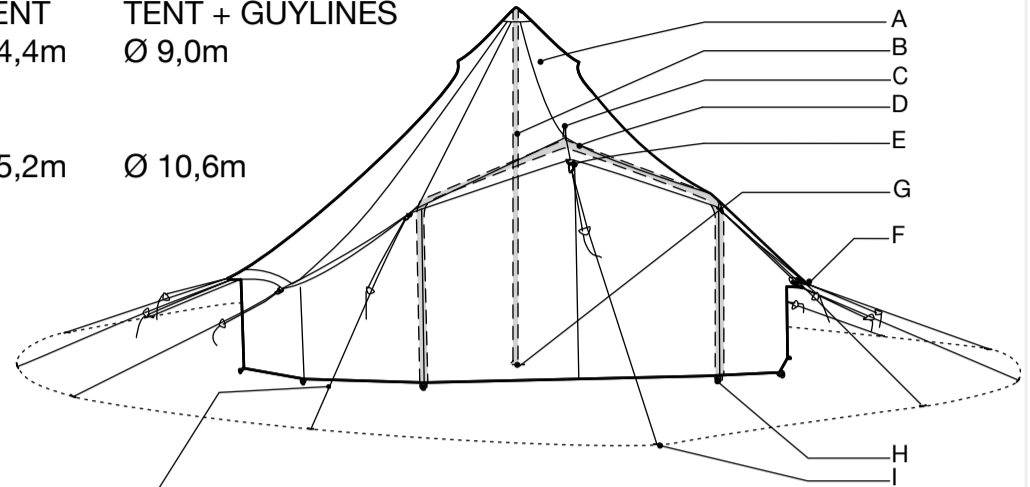

When breaking down the tent, always remove all guylines and store them in a separate bag to avoid colour stains on the tent fabric.

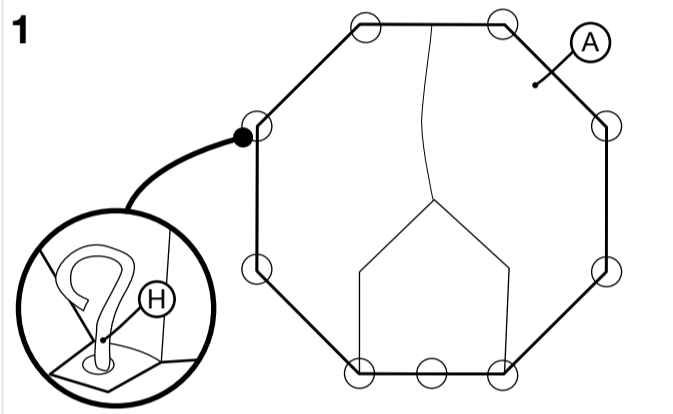

1 Make sure all zips are closed. Place all tent pegs, starting with 2 doorpegs and continue with opposite sides. Ensure perfect tensioning of the groundsheet.

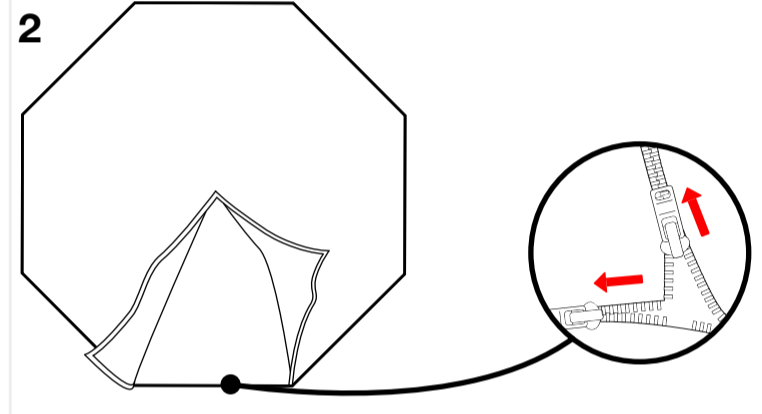

Open the door

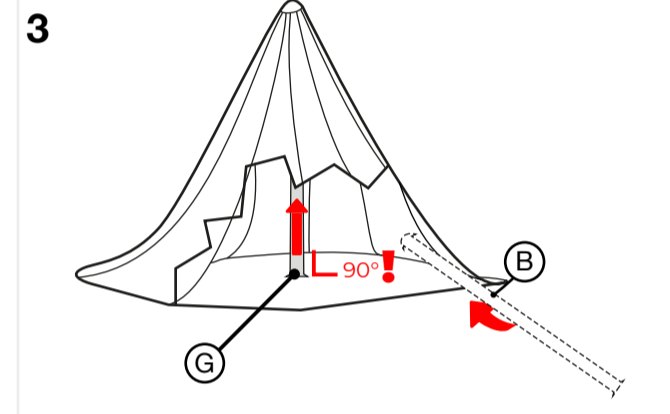

3 Insert center pole and place the pole support to protect the groundsheet. Keep the pole as vertical as possible for optimal wind performance.

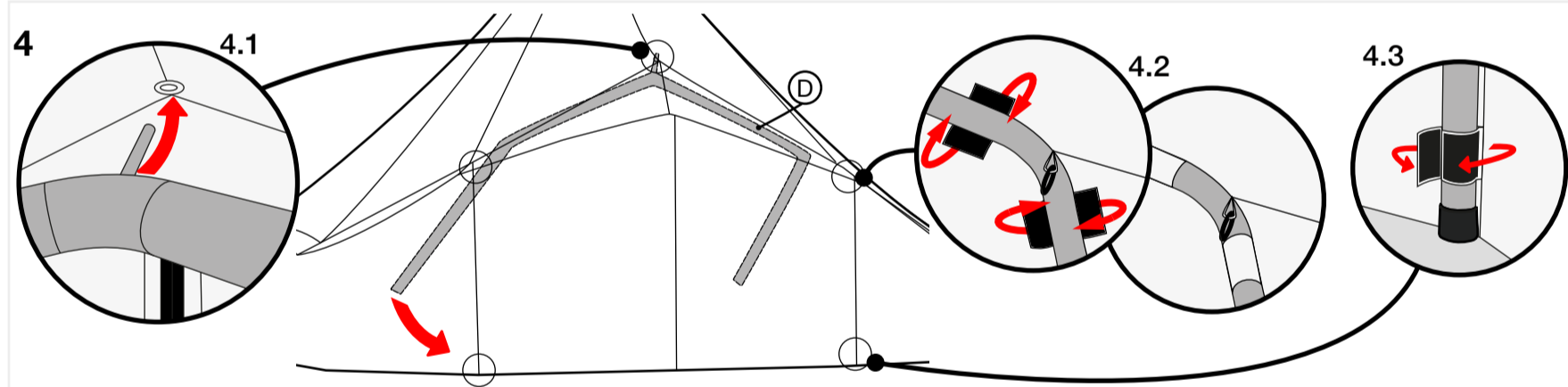

4 Assemble A-frame inside the tent. Insert pin on top and attach velcros around the frame.

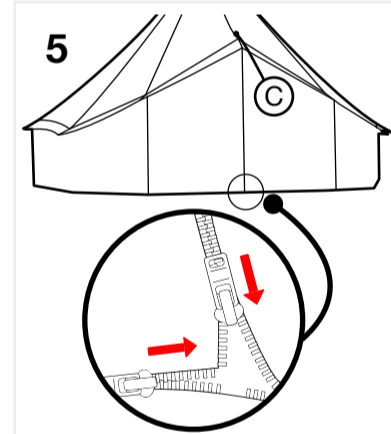

5 Close the door. Place the pole cap (C) on the top pin of the A-frame.

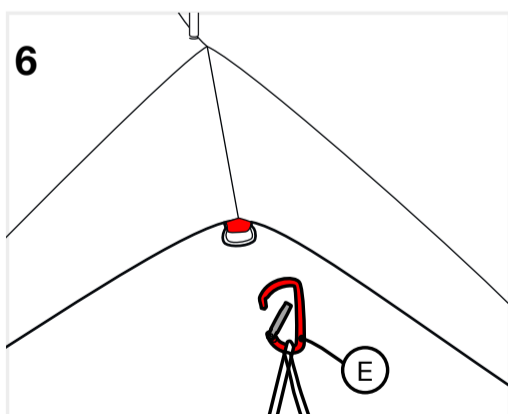

6 Attach the guyline with the orange carabiner (E) at the door in the front.

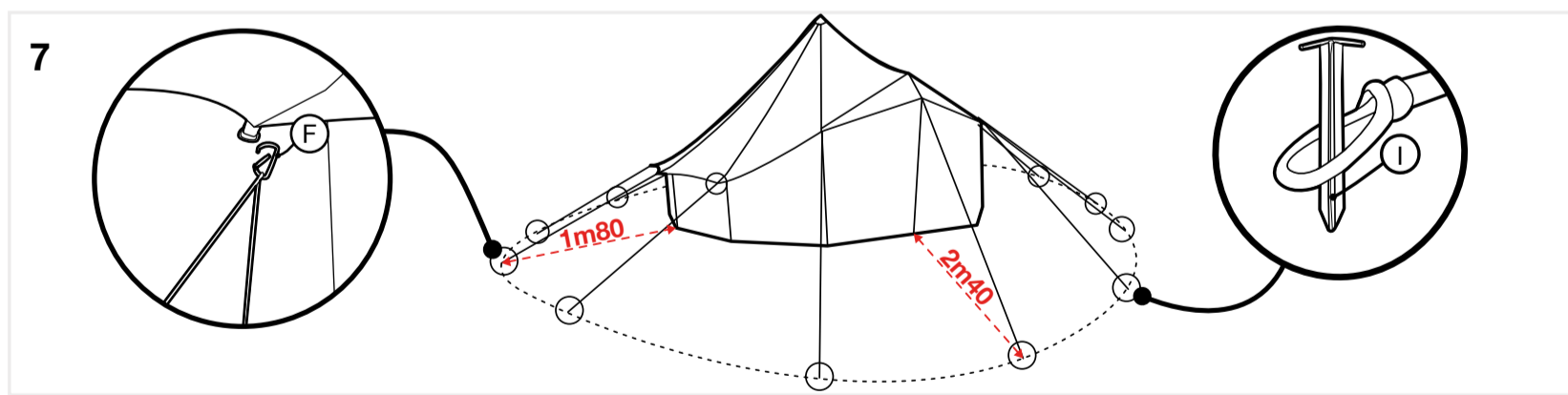

7 Attach all remaining guylines (F), align them to the seams of the roof and peg them down at the distance illustrated above.

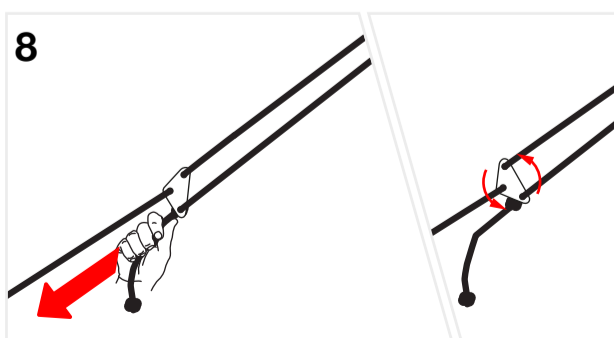

8 Tighten firmly once all guylines are attached. The guyrunner should be diagonal to adjust the tension on the guyline, and horizontal to lock it in place.

Tip: Use optional Short Guy Poles if the guylines can't maintain the illustrated distance or if the tent is pitched on a platform. This will reduce the necessary setup surface and maintain straight walls to prevent water infiltration.

More tips



AUTENTIC.world

FOLDING INSTRUCTIONS

- Make sure your tent is completely dry and clean before folding to prevent mould.
- Ensure that all guylines are entirely dry before storing them. Always store them separately from your tent to avoid colour stains.
- Make sure to always store your tent in a clean, dry and well ventilated place to prevent mould.

More tips



AUTENTIC.world

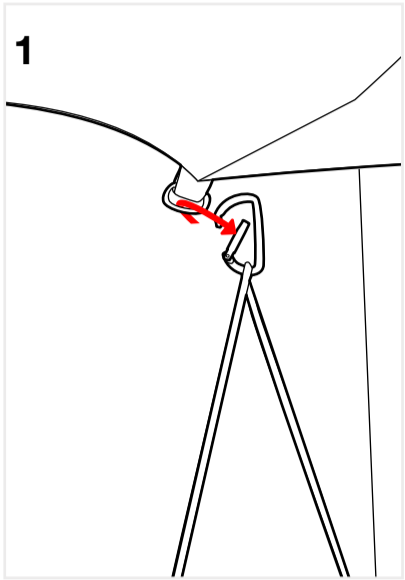

Remove all guylines from the tent and store them in the guyline bag.

