



AUTENTIC

SETUP INSTRUCTIONS

AWNING



PACKING LIST



1 x AWNING (A)

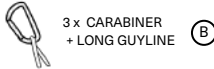

3 x CARABINER + LONG GUYLINE (B)

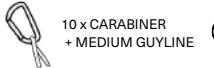

10 x CARABINER + MEDIUM GUYLINE (C)

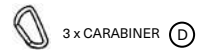

3 x CARABINER (D)



3 x POLES (E)



13 x T-PEGS (F)

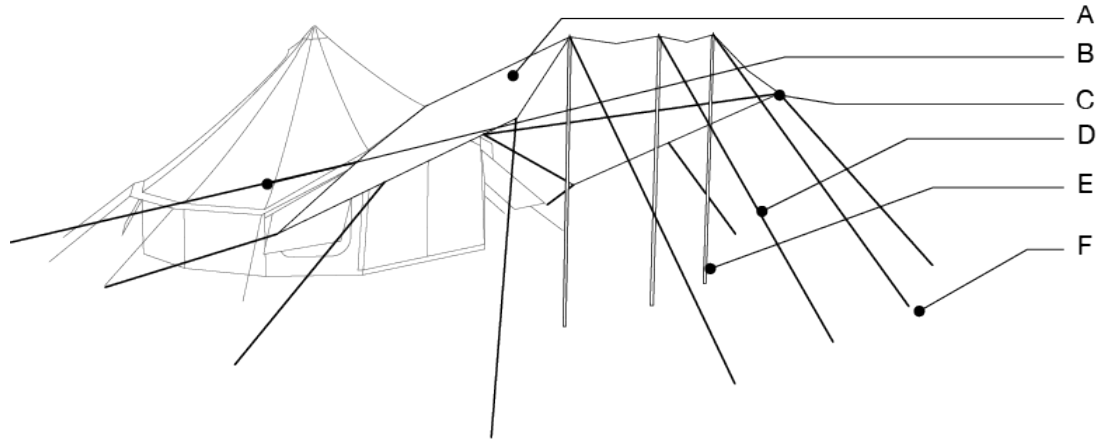

PLEASE READ THIS CAREFULLY BEFORE YOU START THE SETUP OF YOUR AWNING



We advise not to use the awning in extreme weather conditions.



If your awning is made of a cotton based canvas, make sure to wet the entire awning before first use and let it dry completely to ensure its waterproofness.



Make sure to always break down the awning during heavy winds.



When breaking down the awning, always remove all guylines and store them in a separate bag to avoid colour stains on the fabric.



When you have dirty stains on your awning, clean the awning with water and a soft brush and only use cleaning & retreatment products suited for the awning. Don't use a high-pressure cleaner, soap, or aggressive detergents as they can damage the tent's materials and shorten its lifespan.



We do not recommend starting a fire under or around the awning.



Do not make cuts, holes, openings or other alternations to the awning fabric to ensure the awning and fabric's performance.

*Autentic is in no case liable for any damage arising or caused by the product being used or set up contrary to the instructions or used for any purpose other than its intended use.

Always read the latest version of the manual with this QR code



Make sure to read the additional tips for maintenance and usage on [autentic.world](https://www.autentic.world)





AUTENTIC

GENERAL SETUP TIPS

Alternative Anchor Points

Autentic tents come with pegs as the standard solution for anchoring the groundsheet and guylines. Depending on the surface where the awning is pitched on, you might choose for alternative anchor points (sand anchors, concrete anchors, ...). Which ever anchors you decide to use, make sure they are heavy-duty and can hold down the heavy tension of the guylines. Below is our suggestion for the most common set-up: on a wooden platform.

Wooden Platform

If you are pitching the awning on a platform, you can use heavy duty screws and washers as an alternative anchor point. Make sure the platform is thick enough to hold the screws under tension.



OPTIONAL ACCESSORIES

Your awning is compatible with the following accessories to enhance your tent setup. Ask your Autentic reseller or contact Autentic directly to know more.



SHOCK ABSORBERS

- Minimize the impact of heavy winds



CENTER POLE PLATE

- Improves stability of the poles on soft undergrounds (sand, grass, etc)



AUTENTIC

SETUP INSTRUCTIONS

The awning is a flexible product and can be pitched in different set-ups (see last page). Below are the instructions for the most common set-up.

- 1** Pitch your tent and place the awning (A) in front of the tent in the right position. The large reinforced seamline (I) should be aligned with the center of the door. The side with the taped seamlines and D-rings should be facing the floor.

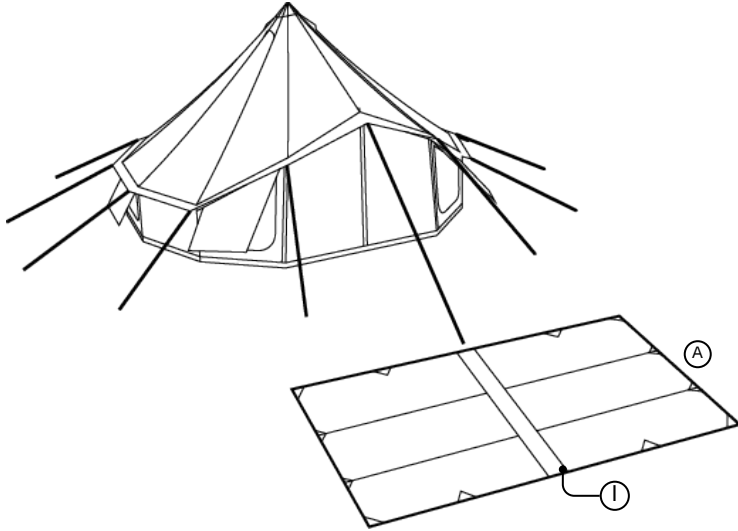

- 2** Remove the raincap of the tent frame and connect the eyelet (hole) of the awning (A) to the A-frame pin. Reinstall the raincap.

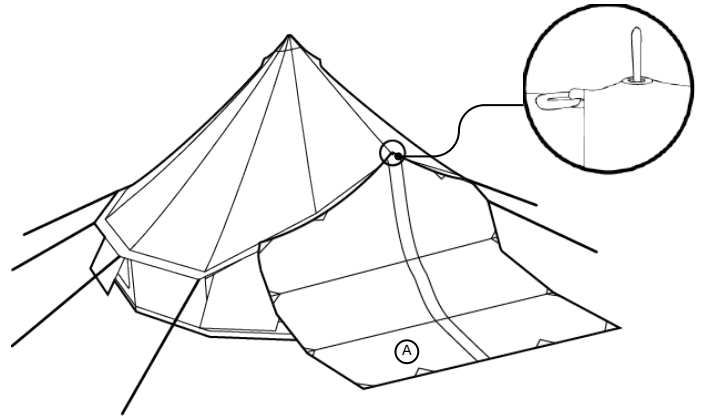

- 3** Attach all guylines on the awning as shown below. Use the longer guylines (B) in the center front and the medium long guylines (C) for the rest as indicated below. Make sure the guylines are attached to the awning as shown on the right image below.

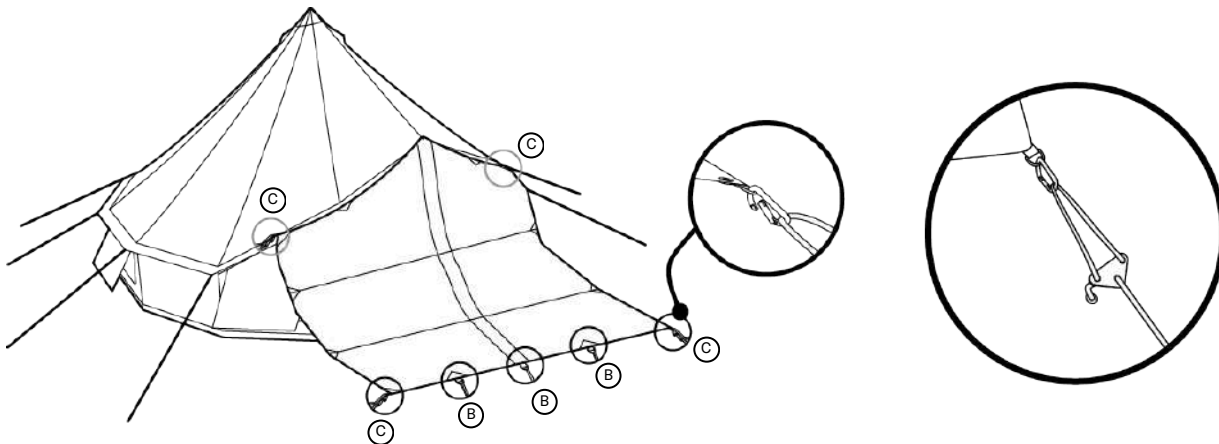

- 4** Install the 2 medium guylines (C) of the corners in the 'back' using the T-pegs (F). Only tension the guylines lightly during this step. Make sure to align the guylines to the seams of the awning for this step and the following steps.

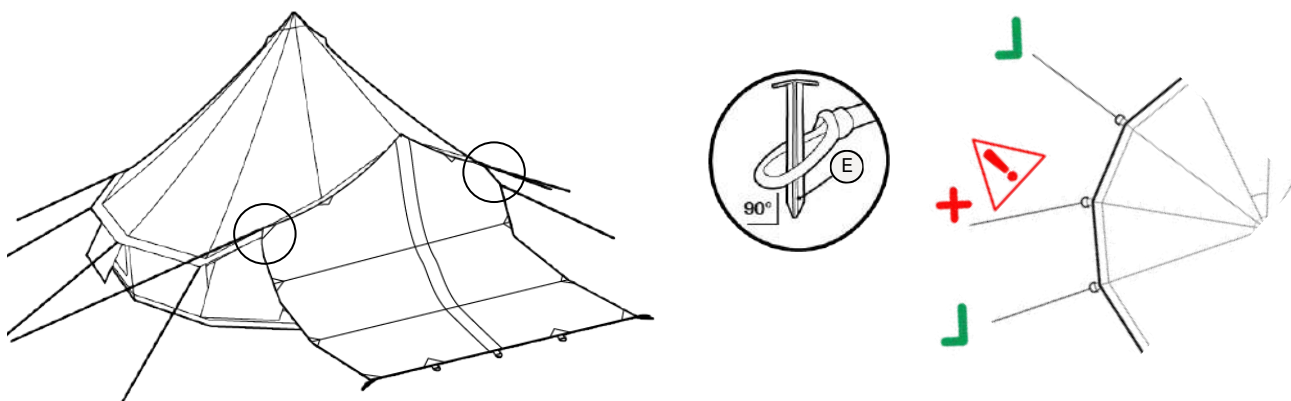



AUTENTIC

5 Install the middle pole (E) in the front of the awning using the long guylines (B). Make sure that the pole is fully vertical at an 90° angle. Only tension the guylines lightly during this step.

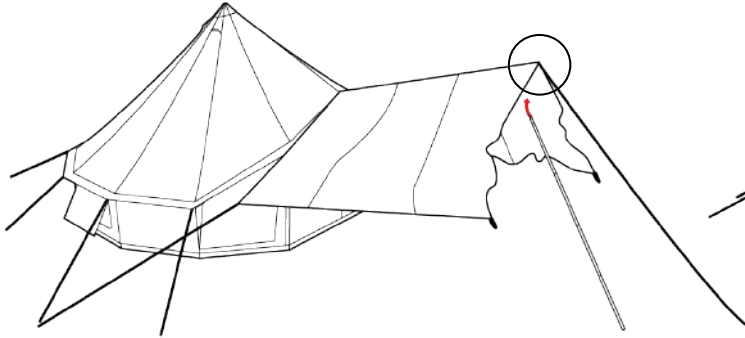

6 Install the 2 guylines in the front corners of the awning using the medium guylines (C). Only tension the guylines lightly during this step.

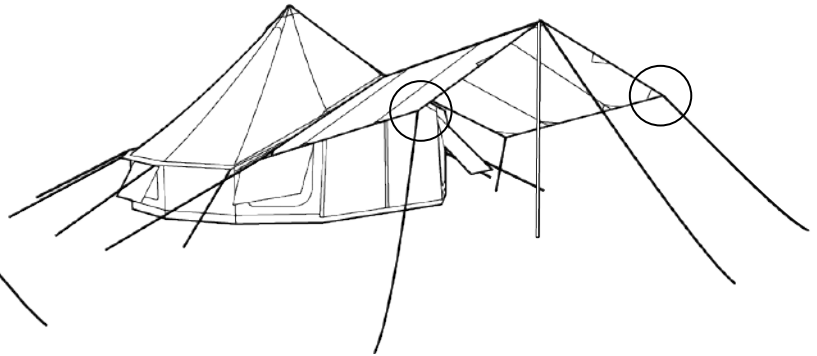

7 Install the 2 remaining poles (E) in the front of the awning using the long guylines (B). Make sure that all poles are fully vertical. Only tension the guylines lightly during this step.

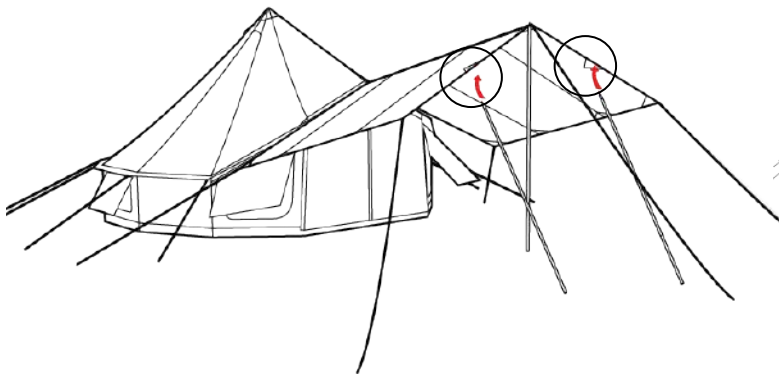

8 Fully tension the 3 long guylines (B) in the center front following the tensioning process on page 5.

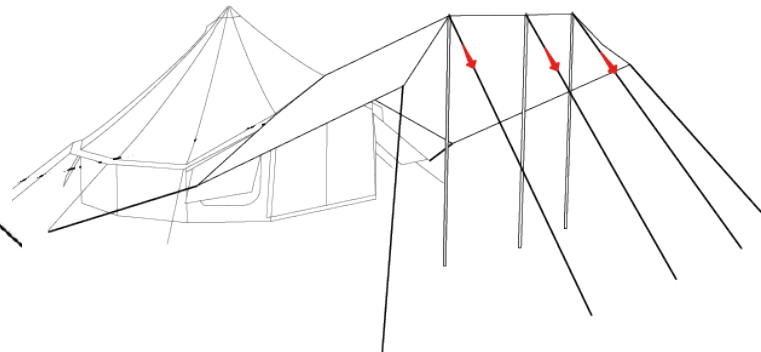

9 Fully tension all the remaining guylines (C), starting with the guylines in the back followed by the guylines in the front corners. Make sure the tension is evenly spread across the awning. If there is too much tension on 1 side, remove tension from that side and add tension to the other side.

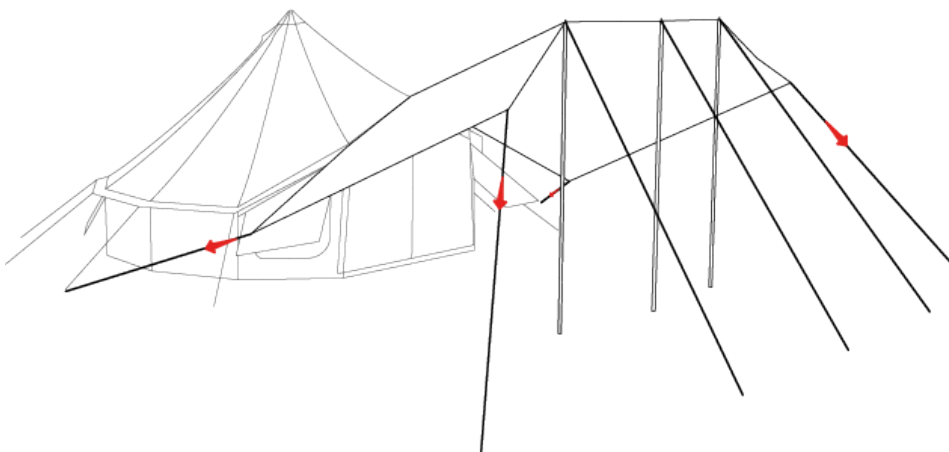



AUTENTIC

10 Uninstall the central front guyline (1) of the tent and connect that guyline to the opposite D-ring of the awning using 1 of the additional carabiners (D). Add tension to the guyline. Repeat the same for the 2 remaining guylines (2).

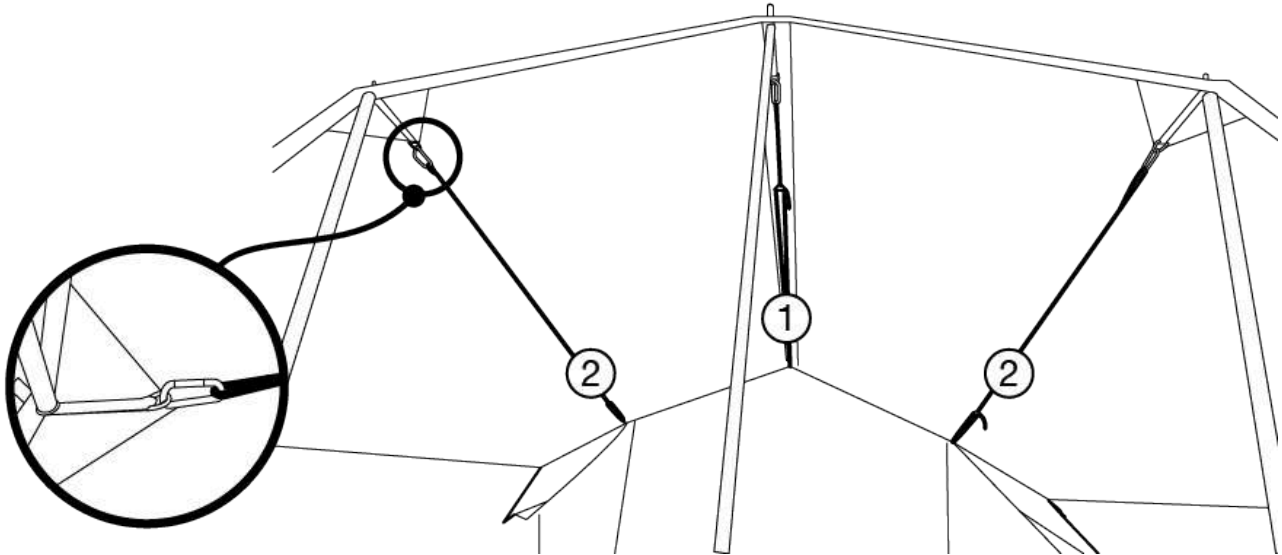

! This set-up example only uses 7 guylines for a clean and aesthetic installation. Use all guylines to ensure a more stable set-up that is more suited to withstand harsher weather conditions.

How to tension guylines



Locked



Unlock the system by aligning the guyrunner with the guyline. You can now freely move it along the guyline.

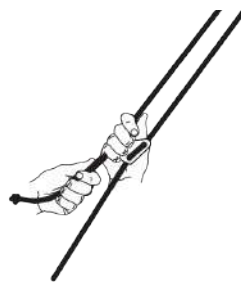

Hold the guylines end together with the guyrunner.

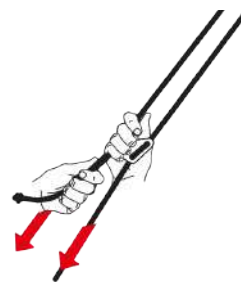

Pull to increase tension.

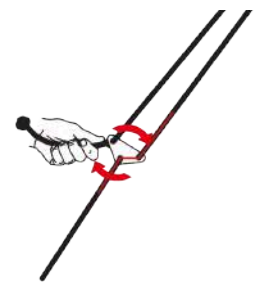

Lock back in place

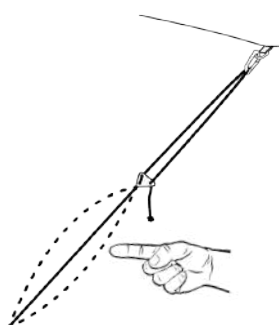

The tension should be firm enough so the awning does not appear as "baggy". Don't over tension the awning either. When tapping the guyline with your finger, you should be able to slightly move it with little effort.

Regularly check the tension on the guylines. Especially before and after there is heavy weather forecasted.



Make sure that the awning is pitched with the roof at an angle so there is a slope for the water to roll off the awning. This will avoid heavy waterpockets that can cause damage.



AUTENTIC

DIFFERENT SETUPS

Various awning configurations are available depending on the height and the number of poles.

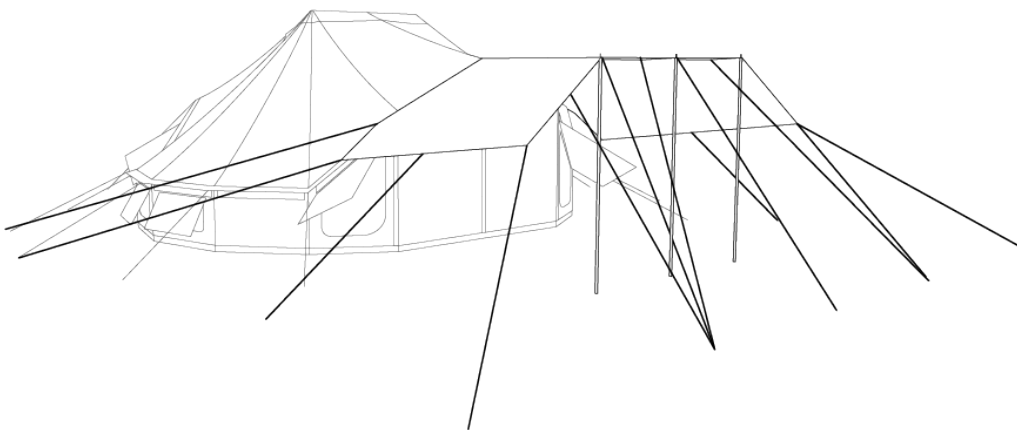
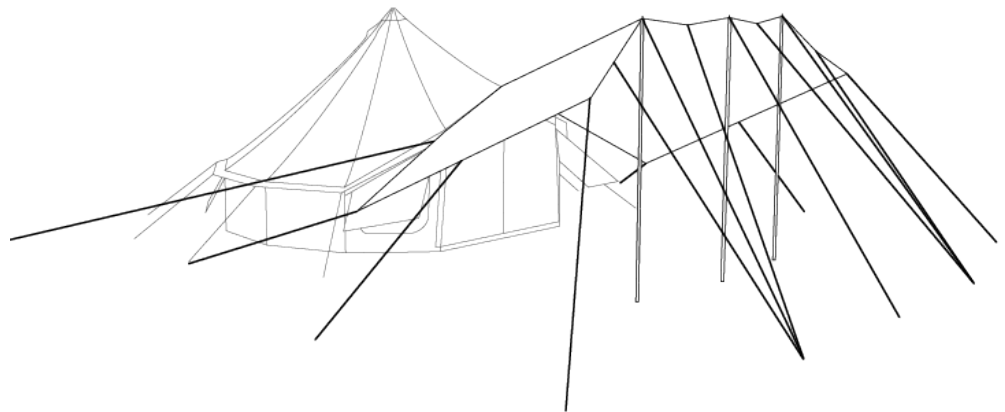
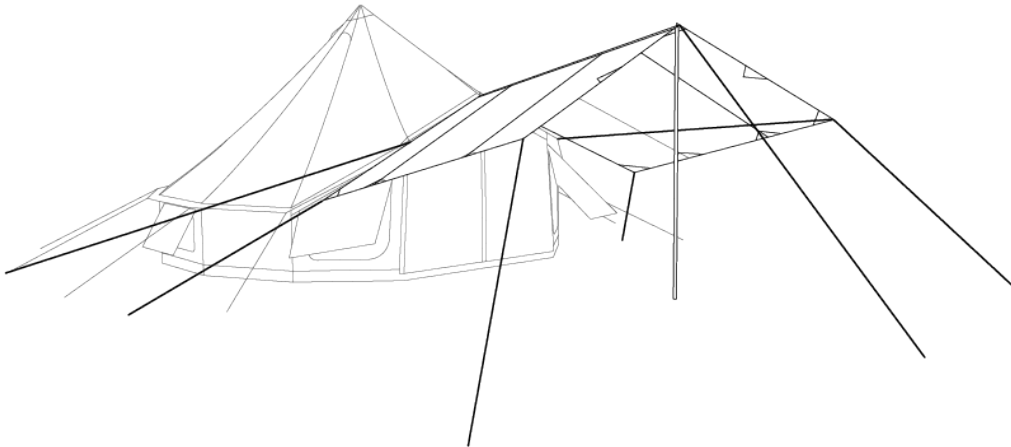

Always read the latest version of the manual with this QR code



Make sure to read the additional tips for maintenance and usage on autentic.world

