











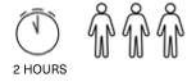

AUTENTIC

# SETUP INSTRUCTIONS

## BILLY-JOE DOUBLE BELL 7.2





### PACKING LIST

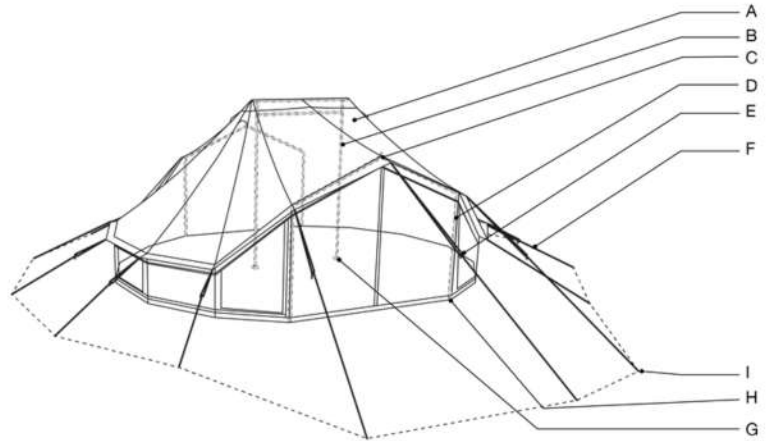

-  1 x TENT (A)
-  10 x CARABINER (F)  
+ LONG GUYLINE
-  1 x CENTER POLE FRAME (B)
-  2 x POLE SUPPORT (G)
-  2 x POLE CAP (C)
-  14 x PEGS (H)
-  2 x A - FRAME (D)
-  16 x T-PEGS (I)
-  6 x COLOURED CARABINER (E)  
+ LONG GUYLINE
-  1 X HAMMER (J)



### PLEASE READ THIS CAREFULLY BEFORE YOU START THE SETUP OF YOUR TENT

-  We advise not to use the tent in extreme weather conditions.
-  If your tent is made of a cotton based canvas, make sure to wet the entire tent before first use and let it dry completely to ensure its waterproofness.
-  Make sure to always close the doors and windows of your tent during heavy winds.
-  When breaking down the tent, always remove all guylines and store them in a separate bag to avoid colour stains on the tent fabric.
-  When you have dirty stains on your tent, clean the tent with water and a soft brush and only use cleaning products suited for the tent. Don't use a high-pressure cleaner, soap, or aggressive detergents as they can damage the tent's materials and shorten its lifespan.

\*Autentic is in no case liable for any damage arising or caused by the product being used or set up contrary to the instructions or used for any purpose other than its intended use.

Make sure to read the additional tips for maintenance and usage on [autentic.world](http://autentic.world)





**AUTENTIC**

# SETUP INSTRUCTIONS

**1**

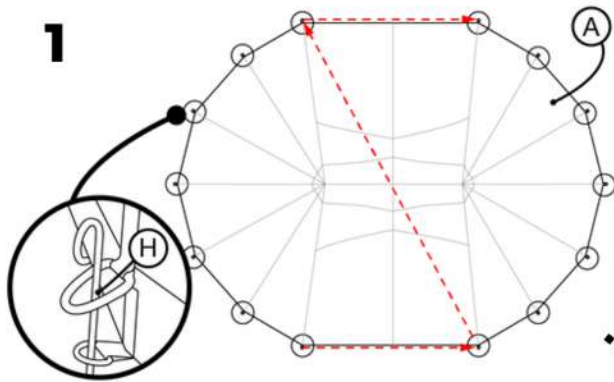

Make sure all zips are closed. Place all pegs (H). Start at the door and continue diagonally. Ensure perfect tensioning of the groundsheet.

**2**

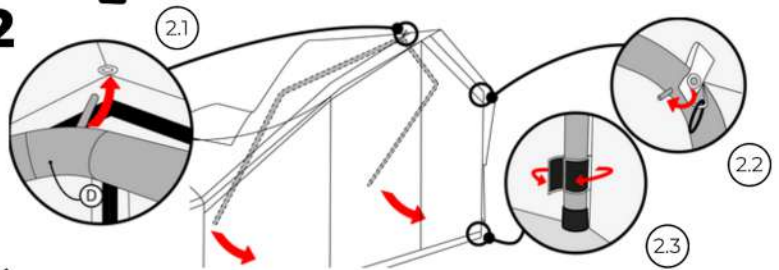

Open the doors. Start with assembling the A-frames (D) inside the tent and insert them both at the front and backside.

2.1: Insert the top pin in the metal eyelet.

2.2: Insert the pins on both sides of the frame.

2.3: Attach all velcro straps around the frames.

Make sure the poles stand vertically.

**3**

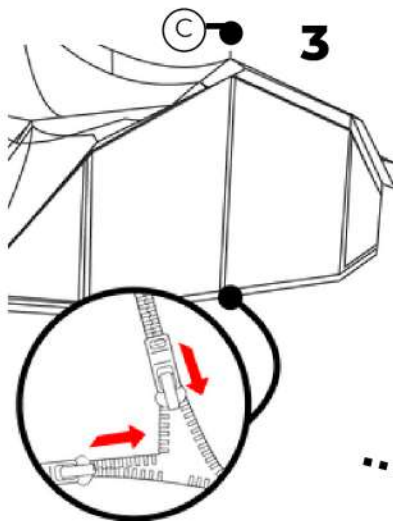

Close both doors. Place the pole caps (C).

**4**

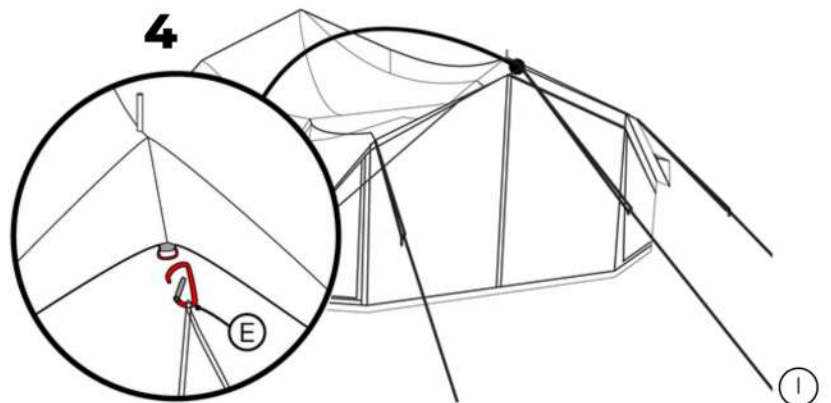

Attach the guylines with orange carabiners (E) to the three guypoints at the front and back doors.

Peg down the guylines using the pegs (I) and tension them lightly.

**5a**

If you have a set of bended H-frame extensions, remove the pole ends from the center frame and install the extensions.





**AUTENTIC**

## 5b

Assemble the center pole frame (B) on the ground.

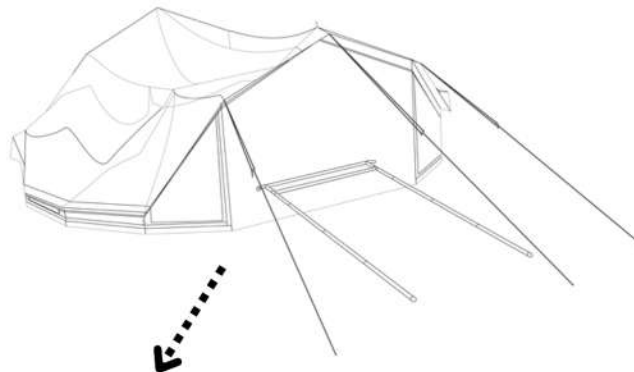

## 6

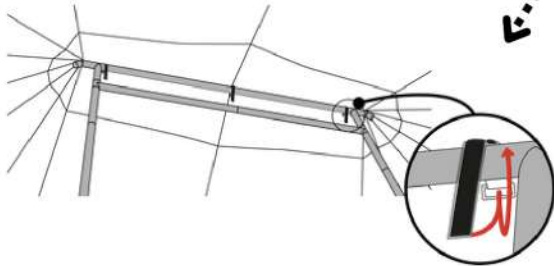

Attach the upper part of the center pole frame (B) to the ceiling of the tent with the velcro straps. Lift the frame and place the pole supports (G) to protect the groundsheet. Keep the poles as vertical as possible for optimal wind performance.

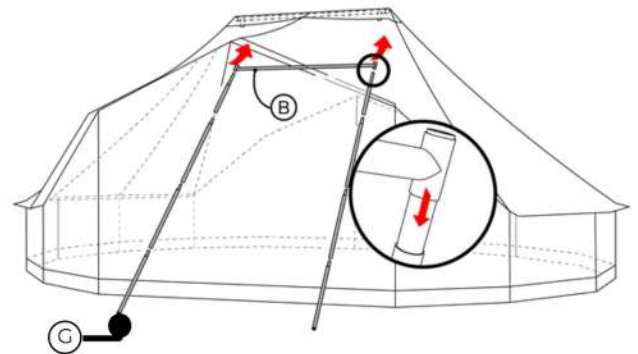

## 7

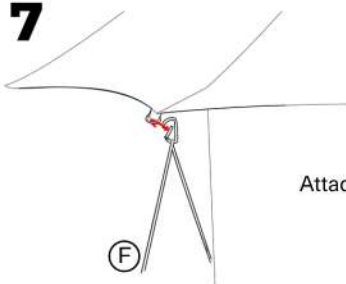

Attach all other guylines (F).

## 8

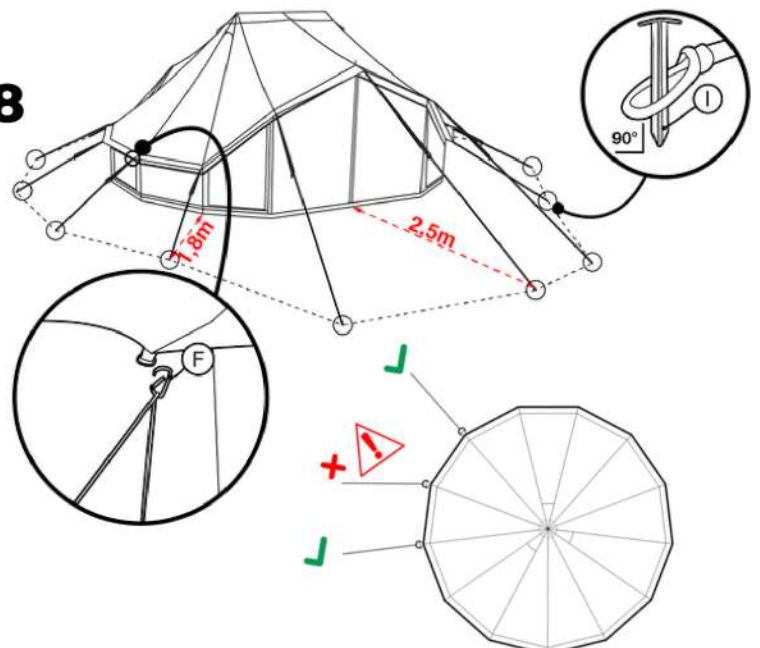

Peg down all guylines using the T-pegs (I). Align the guylines to the seams of the roof with distances as illustrated. To reduce the required setup surface, you can use optional short guy poles. Tension firmly once all guylines are attached.



Take additional safety measures in case of heavy winds and blasts:

If your tent is set up with short guy poles on a wooden platform, attach the poles to the platform.

If you can't attach the short guy poles or if the tent is set up on a grass surface, remove the short guy poles and place the pegs (I) at distances as indicated. Ensure perfect tensioning of the guylines.



**AUTENTIC**

# FOLDING INSTRUCTIONS

Make sure your tent is completely dry and clean before folding to prevent mould.

When breaking down the tent, always remove all guylines and store them in a separate bag to avoid colour stains on the tent fabric.

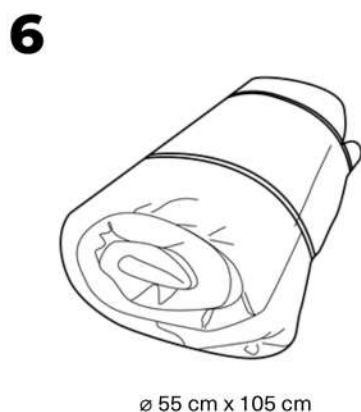
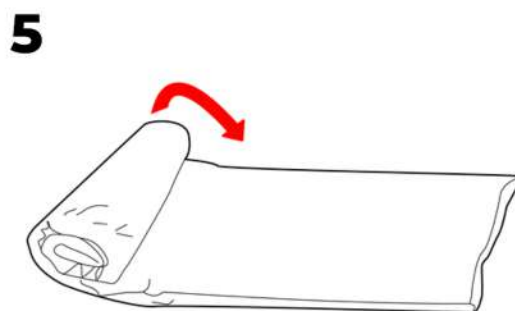
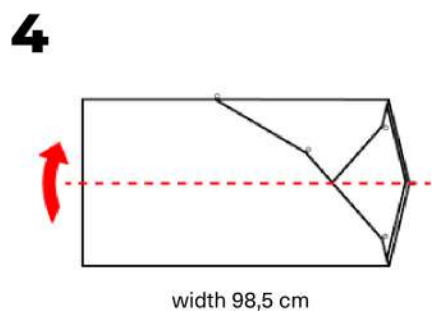
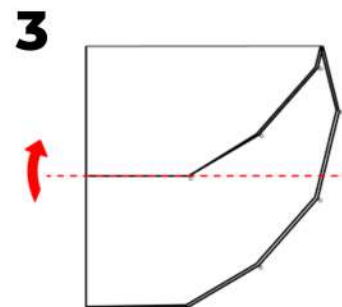
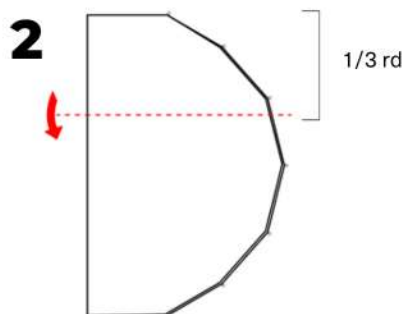
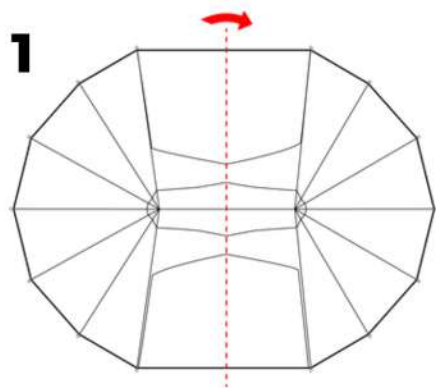

Make sure to read the additional tips for maintenance and usage on [autentic.world](https://autentic.world)

