









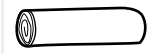

# SETUP INSTRUCTIONS

This tent is a cotton product. Make sure weather your tent before it first use. Wet it completely and let it dry afterwards for complete waterproofness. Check our website for more setup and maintenance tips.

AUTENTIC.world



## PACKING LIST

-  (A) 1x TENT
-  (B) 1x CENTER POLE
-  (C) 1x POLE CAP
-  (D) 1x A-FRAME
-  (E) 3x COLOURED CARABINER + GUYLINE
-  (F) 1x POLE SUPPORT
-  (G) 12x CARABINER + GUYLINE
-  (H) 13x PEG
-  (I) 13x T-PEG
-  (J) 1x HAMMER

	TENT	TENT + GUYLINES
JAY BELL 4.4	Ø4,4m	Ø 9,0m
JACK BELL 5.2	Ø5,2m	Ø 10,6m

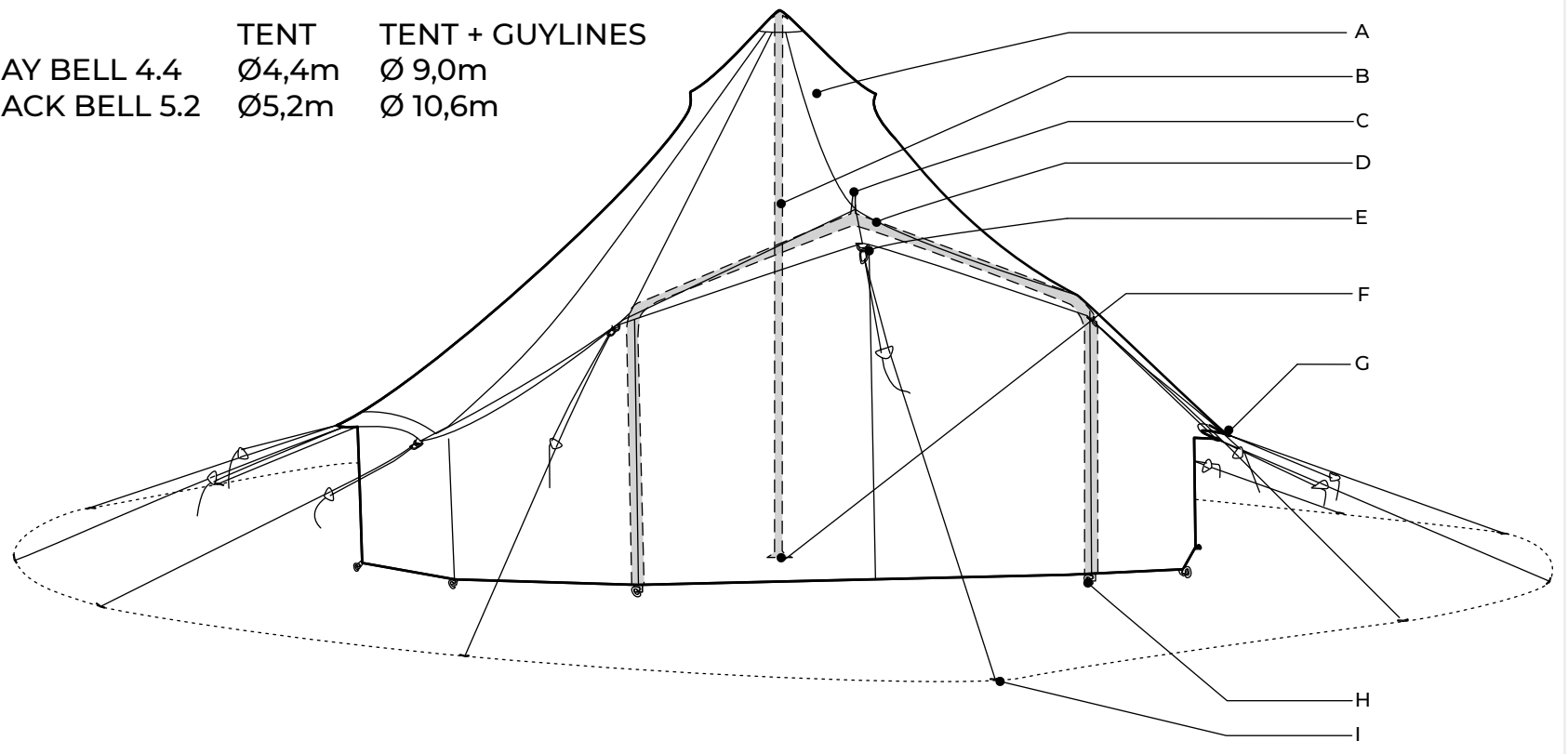

JAY BELL 4.4  
JACK BELL 5.2

 20 min.



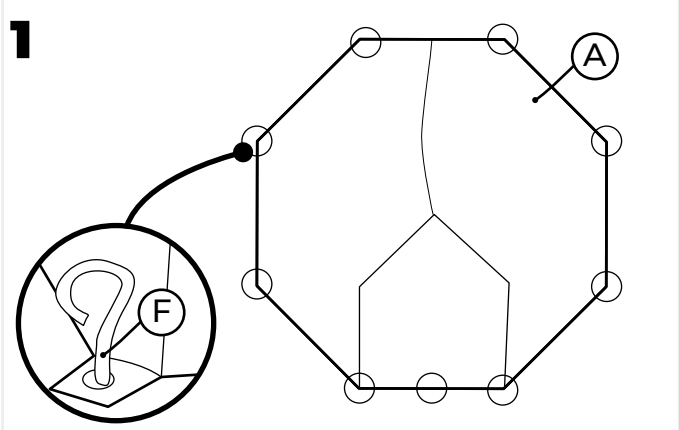

**1** Make sure all zips are closed. Place all tent pegs, starting with 2 doorpegs and continue with opposite sides. Ensure perfect tensioning of the groundsheet.

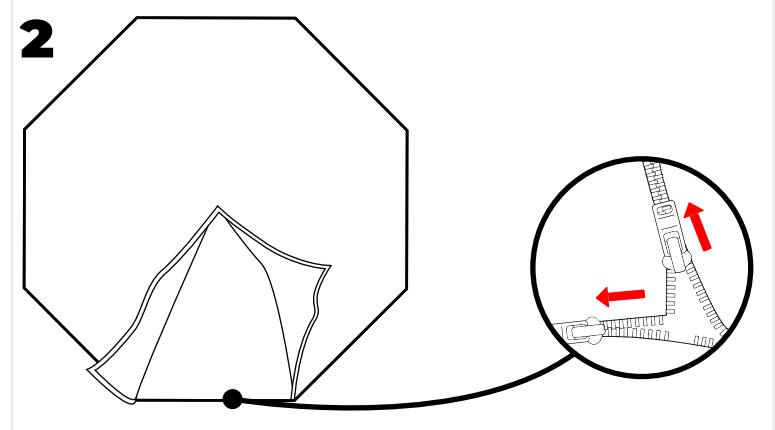

Open door

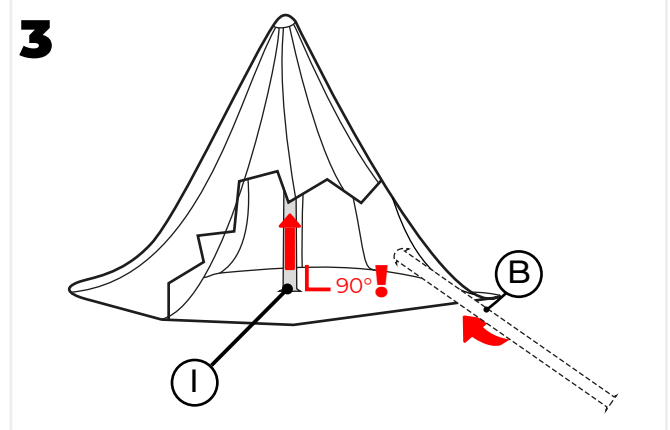

**3** Insert center pole and place the pole support to protect the groundsheet. Keep the pole as vertical as possible for optimal wind performance.

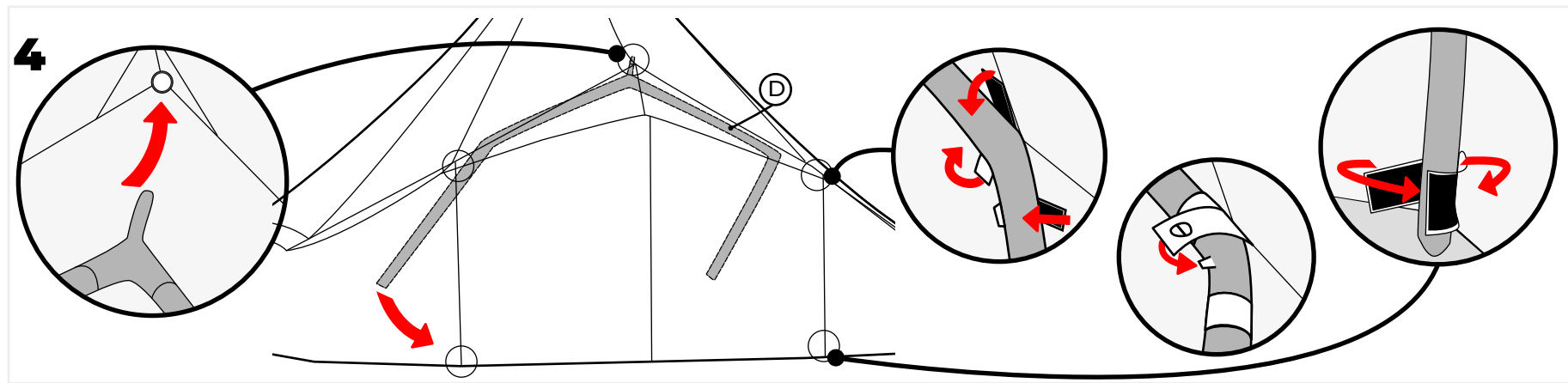

**4** Assemble A-frame inside the tent. Insert pins on top and on both sides, attach strap to the pin and velcros around the frame. Make sure poles stand vertically.

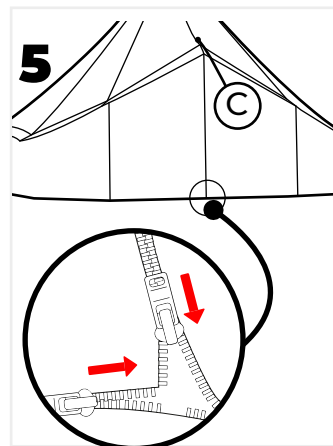

**5** Close the door. Place the pole cap

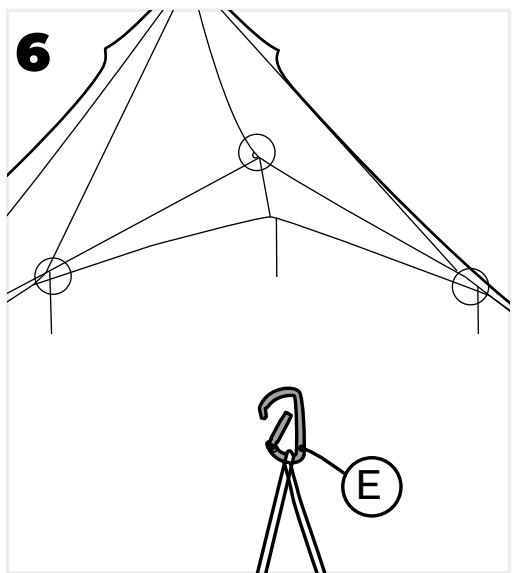

**6** Attach ropes with orange carabiners at the 3 guypoints in the front.

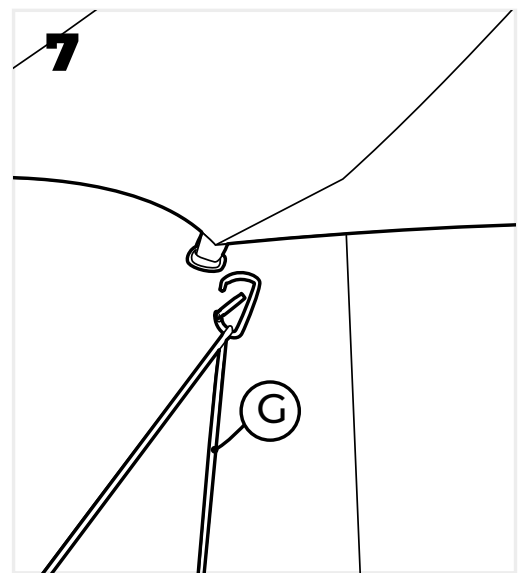

**7** Attach all other Guylines.

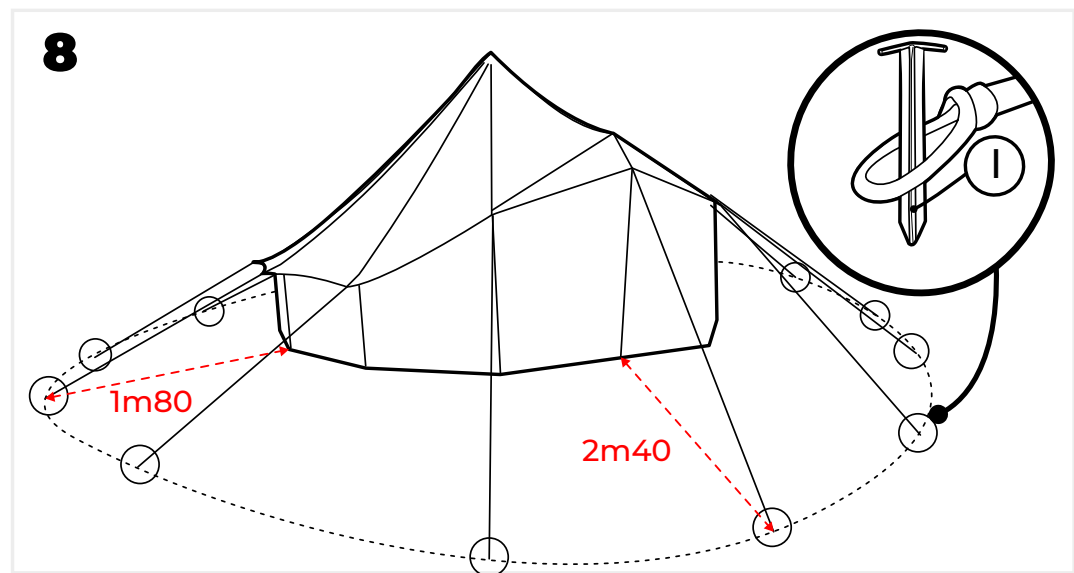

**8** Peg down all guylines. Tension in line with the seams coming from the roof-tip. The 3 lines in front at 2m40. All others at 1m80. Once all are attached, tension firmly.

(the 1m80 can be brought down to 70cm with the Autentic short pole kit)